

LEDON

pioneering light

Downlight Einbaurahmen

Wir haben die perfekt passenden Einbaurahmen für unser LED-Downlight im Sortiment. Mit einem deutlich hörbaren „Click“ rastet das Leuchtmittel im Rahmen ein und lässt sich in zwei Richtungen um 45 Grad schwenken. Ob eckig oder rund, ob in Weiß, Silber oder gebürstetem Aluminium, für jedes 68 mm Einbauloch führen wir den optimalen Einbaurahmen.



BESCHREIBUNG	ARTIKELNUMMER	EAN CODE	AUSFÜHRUNG
DOWNLIGHT FRAME 90/BRUSHED-AL/SQ/S/CLICK-IN	28000524	9 009453 006271	gebürstetes Aluminium, quadratisch
DOWNLIGHT FRAME 90/BRUSHED-AL/RD/S/CLICK-IN	28000525	9 009453 006288	gebürstetes Aluminium, rund

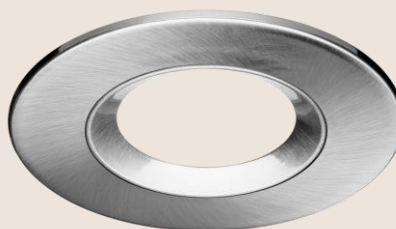

BESCHREIBUNG	ARTIKELNUMMER	EAN CODE	AUSFÜHRUNG
DOWNLIGHT FRAME 90/9016-W/SQ/S/CLICK-IN	28000526	9 009453 006059	weiß (RAL 9016), quadratisch
DOWNLIGHT FRAME 90/9016-W/RD/S/CLICK-IN	28000527	9 009453 006066	weiß (RAL 9016), rund

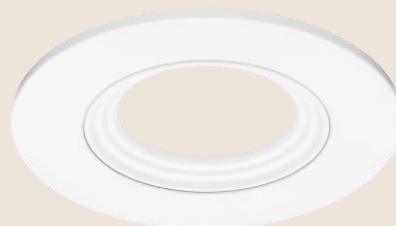
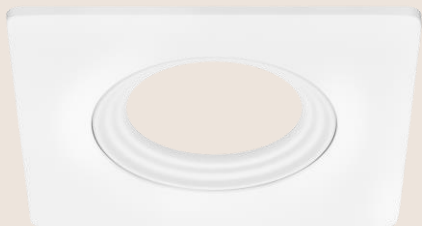

BESCHREIBUNG	ARTIKELNUMMER	EAN CODE	AUSFÜHRUNG
DOWNLIGHT FRAME 90/9022-S/SQ/S/CLICK-IN	28000528	9 009453 006073	silber (RAL 9022), quadratisch
DOWNLIGHT FRAME 90/9022-S/RD/S/CLICK-IN	28000529	9 009453 006080	silber (RAL 9022), rund

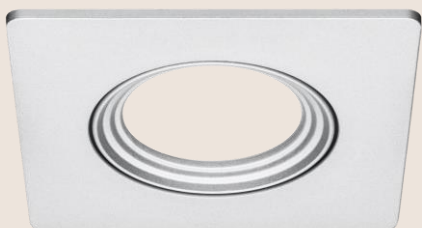

ABMESSUNGEN

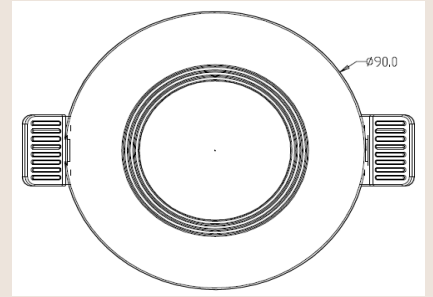
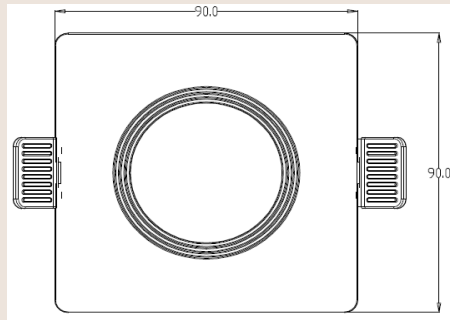
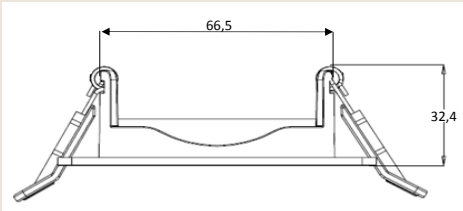

INSTALLATIONSANLEITUNG

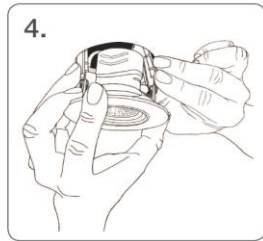
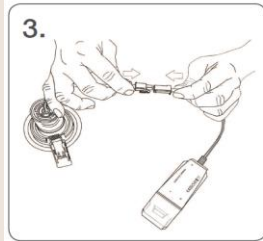
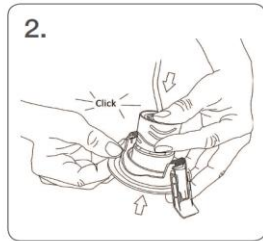
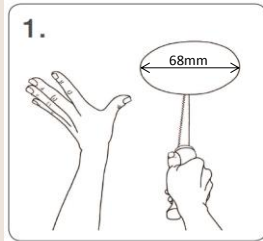

LEDON

 Diese Leuchte ist geeignet für Leuchtmittel der Energieklassen:

A⁺⁺
A⁺
A
B
C
D
E

874/2012 